

FLOS

F020G3LH001 White

Outgraze 35 Easy L 900 mm White

Designed by FLOS Outdoor



24V remote power supply and installation brackets to be ordered separately.
Dimmable PWM luminaires. Sandblasted glass.

Are you a professional and your project needs consulting and support?

[BOOK AN APPOINTMENT](#)

Main specifications

Mounting	Ceiling and wall surface
Environments	Outdoor wet location
LED type	Power LED
Lamp category	LED
Icos	No
Power (W)	13
System flux (lm)	621

Physical

Colour	White
Trim	No
Orientation	Adjustable
Transversal tilting (°)	180
Length (mm)	900
Net weight (kg)	2.32
IP internal	66

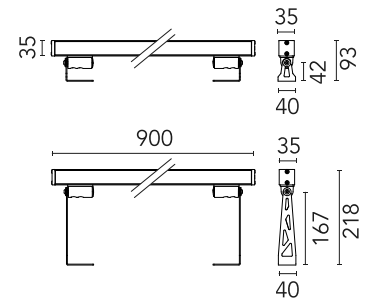

Download

[Mounting instructions](#) ZIP

Photometric Files

[LDT / IES](#) ZIP

Technical Drawings

[2D](#) ZIP

[3D](#) ZIP

[Bim](#) ZIP



Schematic light drawing

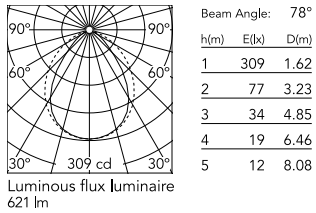

Photometric

Lighting type	Direct
Light distribution	Symmetric
CCT (K)	3000
CRI>	80
Beam angle C0-180 (°)	90
Beam angle C90-270 (°)	90

Electrical

Insulation class	III
Frequency (Hz)	50-60
Main voltage (Vac)	24
Driver	Remote
Dimmable	Yes
Dimming type	Dimmable DALI PWM, Dimmable 1-10 PWM
Emergency type	No

Ecodesign and Energy Labelling

This product contains a light source of energy efficiency class E



Replaceable (LED only) light source by a professional



Replaceable control gear by a professional

Notes

We recommend using a connection system with a degree of protection greater than or equal to the degree of protection of the luminaire.

During the installation and the maintenance of the fixtures it is important to be careful and avoid damages on the paint coating.

Damages on the coating exposed to outdoor conditions or water, could cause corrosion.

Chemical substances affect the anticorrosion covering protection.

For LED fixtures, there is evidence that most of the damages are connected to electrical effects related to the insulations, which cause destructive electrical discharges

These effects are frequently caused by:

- over voltage coming from the mains' network where fixture is connected.
- electrostatic discharge (ESD) coming from the environment.

The use of a protective device against the overvoltage on the electrical installation is warmly suggest this helps to reduce the intensity of some of these phenomenon and prevent irreversible damages. The selection of the type of device to be used must be adjust on the electrical plant.

Accessories & Power Supply



REQUIRED
Accessory

F1204001

One pair of long brackets L 200 mm. White



REQUIRED
Accessory

F1203001

One pair of short brackets L 80 mm. White



REQUIRED
Power supply

F990B07A000

CONTROL INTERFACE 24V PWM - DALI IP20 CLASS III. Vin 24Vdc 120W (POWER SUPPLY NOT INCLUDED)



REQUIRED
Power supply

F990B14A000

CONTROL INTERFACE 24V PWM - 1..10V IP20 CLASS III. VIN 24Vdc 120W (POWER SUPPLY NOT INCLUDED)



REQUIRED
Accessory

F990C00A000

2 way terminal block 4 poles IP68 H20 stop. (ø5,5÷12mm cable)



REQUIRED
Accessory

F990C010000

3/4 way terminal block 4 poles IP68 H20 stop. (ø5,5÷12mm cable)



REQUIRED
Power supply

RF25749

Power supply 24Vdc 70W / 220-240V IP67 Class II selv. Non Dimmable



REQUIRED
Power supply

RF25755

Power supply 24Vdc 50W / 120-240V IP67 Class II selv. Non Dimmable



REQUIRED

Power supply

RF25756

Power supply 24Vdc 100W /
120-240V IP67 Class II selv.Non
Dimmable